

SHARP®

Digital Terrestrial HD Recorder

MODEL

TU-T2HR32

OPERATION MANUAL

Thank you for purchasing this SHARP product. To obtain the best performance from this product, please read this manual carefully. It will guide you in operating your SHARP product.

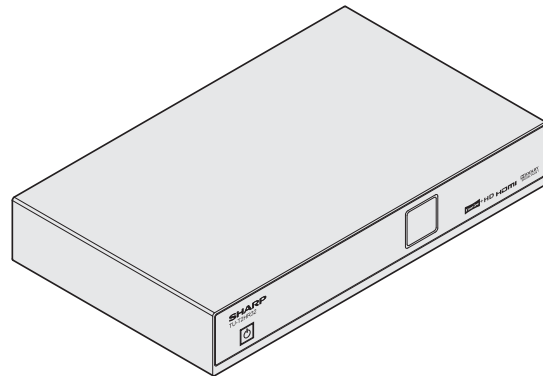

Manufactured under license from Dolby Laboratories. Dolby and the double-D symbol are trademarks of Dolby Laboratories.



HDMI, the HDMI logo and High-Definition Multimedia Interface are trademarks or registered trademarks of HDMI Licensing LLC.

Important: This product can only receive Digital Terrestrial TV signals, subject to coverage an aerial upgrade may be required. Text your postcode followed by your house name or number to 83331* or go to www.freeview.co.uk/availability (*Costs no more than a normal text).

- 1 Read this operation manual carefully.
- 2 If you still encounter a problem, please call our service help line on 0845 880 0421 during normal weekday office hours.

OPERATION MANUAL

ENGLISH

- The illustrations and the OSD in this operation manual are for explanation purposes and may vary slightly from the actual operations.
- The examples used throughout this manual are based on the TU-T2HR32 model.

Dear SHARP customer

Thank you for your purchase of the SHARP Digital Terrestrial HD Recorder. To ensure safety and many years of trouble-free operation of your product, please read **Important safety precautions** carefully before using this product.

Contents

Contents	2	Connecting external devices	15
Introduction	3	Video connections.....	15
Important safety precautions.....	3	Audio connections.....	17
Remote control unit.....	4	Menu operation	18
Recorder (front view).....	5	What is the MAIN MENU?.....	18
Recorder (rear view).....	5	Basic adjustment	19
Preparation	6	AV Settings.....	19
Supplied accessories.....	6	Languages.....	21
Inserting the batteries.....	7	Parental Control.....	22
Using the remote control unit.....	7	Freeview+.....	23
Quick guide	8	General.....	24
Initial installation overview.....	8	Library.....	26
Before turning on the power.....	9	Scheduled Recordings.....	26
Initial auto installation.....	9	Appendix	27
Watching TV	10	Troubleshooting.....	27
Daily operation.....	10	Specifications.....	28
Channel List.....	11	PIN CODE reminder.....	29
Selecting a programme using the EPG.....	12	Trademarks.....	29
Digital text.....	13	End of life disposal.....	30
Recording TV	14	Digital Switchover and Your TV Equipment.....	31
Recording a programme.....	14		
Playing a recorded programme.....	14		
Library.....	14		

Introduction

Important safety precautions

- **Cleaning**—Unplug the AC power adapter from the AC outlet before cleaning the product. Use a damp cloth to clean the product. Do not use liquid cleaners or aerosol cleaners.
- Use a soft damp cloth to gently wipe the product when it is dirty. To protect the product, do not use a chemical cloth to clean it. Chemicals may cause damage or cracks in the casing of the product.
- **Water and moisture**—Do not use the product near water, such as bathtub, washbasin, kitchen sink, laundry tub, swimming pool and in a wet basement.
- Do not place vases or any other water-filled containers on this product. The water may spill onto the product causing fire or electric shock.
- **Stand**—Do not place the product on an unstable cart, stand, tripod or table. Doing so can cause the product to fall, resulting in serious personal injuries as well as damage to the product. Use only a cart, stand, tripod, or table recommended by the manufacturer or sold with the product.
- When relocating the product placed on a cart, it must be moved with utmost care. Sudden stops, excessive force and uneven floor surface can cause the product to fall from the cart.
- **Ventilation**—The vents and other openings in the casing are designed for ventilation. Do not cover or block these vents and openings since insufficient ventilation can cause overheating and/or shorten the life of the product. Do not place the product on a bed, sofa, rug or other similar surface, since they can block ventilation openings. This product is not designed for built-in installation; do not place the product in an enclosed place such as a bookcase or rack, unless proper ventilation is provided or the manufacturer's instructions are followed.
- **Heat sources**—Keep the product away from heat sources such as radiators, heaters, stoves and other heat-generating products (including amplifiers).
- To prevent fire, never place any type of candle or naked flames on the top or near the product.
- To prevent fire or shock hazard, do not place the AC power adapter under the product or other heavy items.
- The product uses power even in Standby. Unplug the product from the AC outlet when you are not using it.
- **Servicing**—Do not attempt to service the product yourself. Removing covers can expose you to high voltage and other dangerous conditions. Request a qualified person to perform servicing.

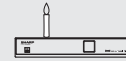

Devices connected to the protective earthing of the building installation through the MAINS connection or through other devices with a connection to protective earthing and to a television distribution system using coaxial cable, may in some circumstances create a fire hazard. Connection to a television distribution system therefore has to be provided through a device providing electrical isolation within a certain frequency range (galvanic isolator, see EN 60728-11).

NOTE

- For requirements in Norway and Sweden, the requirements for isolation are also relevant for devices that can be connected to television distribution systems.

Introduction

Remote control unit

- 1 MUTE**
Volume on/off.
- 2 NUMERIC BUTTONS**
Set the channel
Enter desired numbers
Set the page in Digital Text Mode.
- 3 REC**
Record selection (Page 14).
- 4 PLAYBACK NAVIGATION**
Play, Pause, Stop, Fast Fwd
Fast Rwd, Skip Fwd, Skip Rwd.
- 5 CURSOR**
Select a desired item on the "MENU" screen (Page 18).
- 6 GUIDE**
Display the EPG.
- 7 VOLUME**
Increase/decrease the volume (Page 10).
- 8 MENU**
"MENU" screen on/off (Page 18).
- 9 BACK**
Return to the previous "MENU" screen.
- 10 TEXT**
Display Digital Text (Page 13).
- 11 SUBT**
Switch subtitles on/off (Page 21).
- 12 AD**
Switch Audio Description on/off (Page 21).
- 13 A/V**
Switch to HDMI output or SCART output (Page 10).
- 14 HDMI**
Hold this button down for 5 seconds to revert the output to 1080i (Page 19).
- 15 LIBRARY**
Display "LIBRARY" information (Page 26).
- 16 STANDBY/ON**
Switch between Standby and On (Page 10).
- 17 LAST**
Toggle between the current channel and the previous channel (Page 10).
- 18 PROG**
Select the programme.
- 19 INFO**
Display programme information (Page 10).
- 20 EXIT**
Exit the "MENU" screen.
- 21 COLOUR BUTTONS**
The colour buttons are correspondingly used to select the coloured item on the screen e.g. Digital Text.
- 22 AUDIO**
Select the desired audio language.
- 23 WIDE**
Select a wide mode (Page 19).

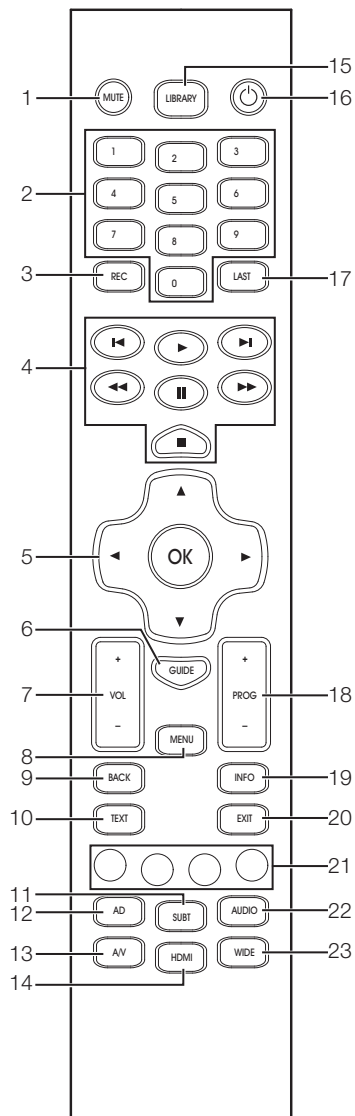

Introduction

Recorder (front view)

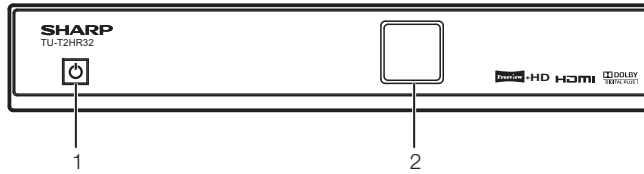

- 1 (Power button)
- 2 Display

Recorder (rear view)

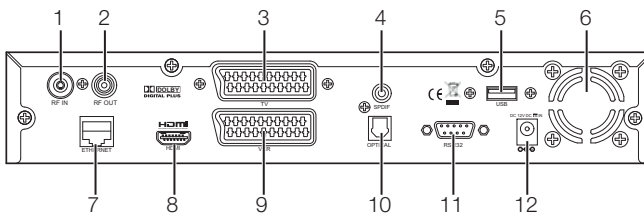

- 1 RF IN (Antenna in) terminal
- 2 RF OUT (Antenna out) terminal
- 3 TV (SCART) terminal
- 4 SPDIF (Digital audio output) terminal
- 5 USB terminal - (For service only)
- 6 Cooling fan outlet
- 7 Ethernet terminal
- 8 HDMI terminal
- 9 VCR (SCART) terminal
- 10 Optical (infra red) terminal
- 11 RS232 terminal - (For service only)
- 12 12V DC terminal

Preparation

Supplied accessories

Remote Control Unit (x 1)

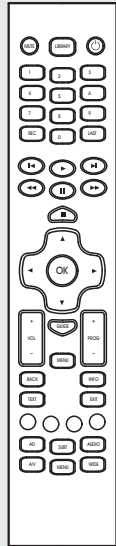

Page 4

Power Adaptor (x 1)

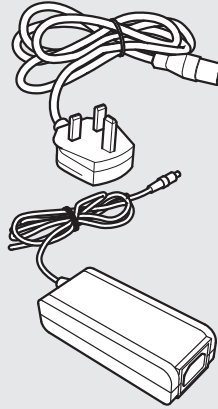

Page 9

RF Cable (x 1)

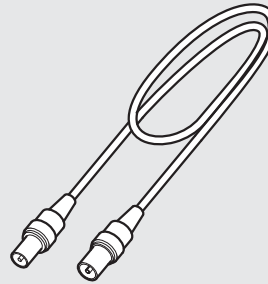

Page 9

- Operation manual (this publication)
- "AAA" size zinc-carbon battery (x2) Page 7

Preparation

Inserting the batteries

Before using the Recorder for the first time, insert the two supplied "AAA" size zinc-carbon batteries. When the batteries become depleted and the remote control unit fails to operate, replace the batteries with new "AAA" size batteries.

- 1 Open the battery cover.**
- 2 Insert the two supplied "AAA" size zinc-carbon batteries.**
 - Place batteries with their terminals corresponding to the (+) and (-) indications in the battery compartment.
- 3 Close the battery cover.**

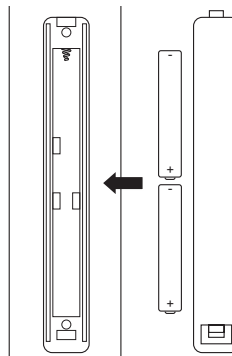

CAUTION

Improper use of batteries can result in chemical leakage or explosion. Be sure to follow the instructions below.

- Do not mix batteries of different types. Different types of batteries have different characteristics.
- Do not mix old and new batteries. Mixing old and new batteries can shorten the life of new batteries or cause chemical leakage in old batteries.
- Remove batteries as soon as they have worn out. Chemicals that leak from batteries can cause a rash. If you find any chemical leakage, wipe thoroughly with a cloth.
- The batteries supplied with this product may have a shorter life expectancy due to storage conditions.
- If you will not be using the remote control unit for an extended period of time, remove the batteries from it.
- When replacing the batteries, use zinc-carbon batteries instead of alkaline ones.

Note on disposing batteries:

The batteries provided contain no harmful materials such as cadmium, lead or mercury.

Regulations concerning used batteries stipulate that batteries may no longer be thrown out with the household rubbish. Deposit any used batteries free of charge into the designated collection containers set up at commercial businesses.

Using the remote control unit

Use the remote control unit by pointing it towards the front of the Recorder. Objects between the remote control unit and sensor may prevent proper operation.

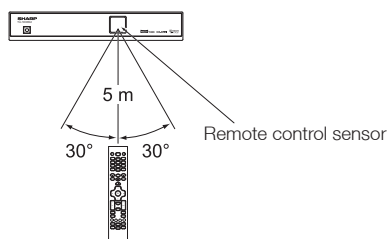

Cautions regarding the remote control unit

- Do not expose the remote control unit to shock. In addition, do not expose the remote control unit to liquids, and do not place in an area with high humidity.
- Do not place the remote control unit under direct sunlight. The heat may cause deformation of the unit.
- The remote control unit may not work properly if the remote control sensor of the Recorder is under direct sunlight or strong lighting. In such cases, change the angle of the lighting or the Recorder, or operate the remote control unit closer to the remote control sensor.

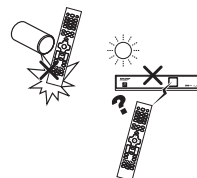

Quick guide

Initial installation overview

Follow the steps below one by one when using the Recorder for the first time.



- 1 Connect the antenna cable to the RF IN terminal (Page 9).

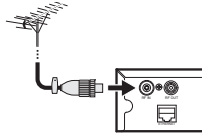

- 2 Connect the Recorder to your TV using the supplied HDMI cable (Page 9).

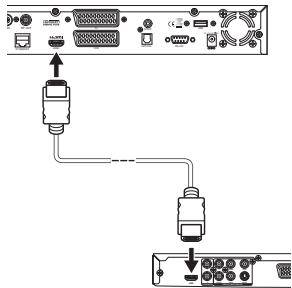

- 3 Connect the power adapter to the Recorder (Page 9).

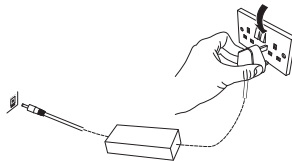

- 1 Turn on the power using the ⏻ button on the Recorder (Page 10).
- 2 Run the first time installation (Page 9).

- ✓ Ensure the antenna is connected

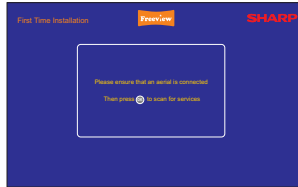

- ✓ Press OK to continue

Start searching channels



- 1 Congratulations! Now you can watch TV.
- 2 If necessary, adjust the antenna to attain maximum signal reception.

Connect external devices

- 1 Connect external devices such as a DVD player/recorder as instructed (Page 15).

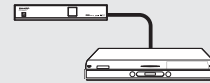

- 2 Connect external audio devices such as speakers/amplifier as instructed (Page 17).



Quick guide

Before turning on the power

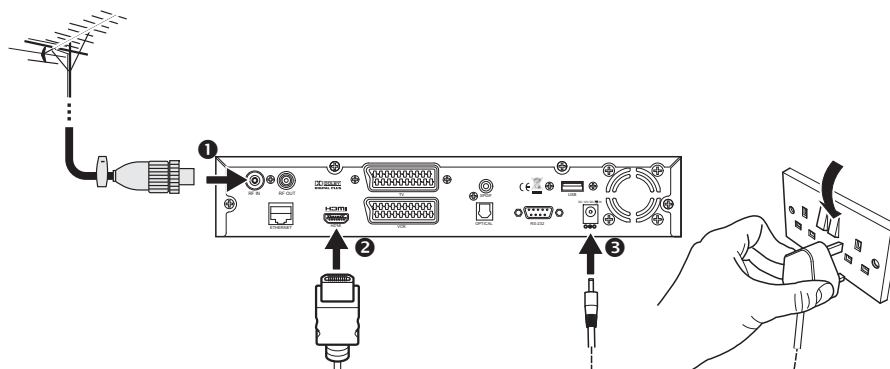

- 1 Connect the antenna (standard DIN45325 plug (IEC 169-2) 75 Ω coaxial cable)
- 2 Connect the HDMI cable
- 3 Connect the power adapter

Place the TV close to the AC outlet, and keep the power plug within reach.

Initial auto installation

When the Recorder is powered on for the first time after purchase, the first time installation screen appears. Follow the on-screen instructions to search for all available channels.

Confirm the following before turning on the power

- Is the antenna cable connected?
- Is the power adapter connected and plugged in?
- Is the HDMI cable connected between the Recorder and your TV?

- 1 Press on the Recorder.
 - The first time installation screen is displayed.
- 2 Ensure the antenna cable is connected.
- 3 Press OK to start the channel search.
 - The Recorder will search for, sort and store all receivable channels.

NOTE

- The first time installation process will be aborted if the Recorder is left unattended for more than 30 minutes before searching for channels.
- After the first time installation has been completed, the default PIN is automatically set to '0000'. To change the PIN setting, refer to Page 22.

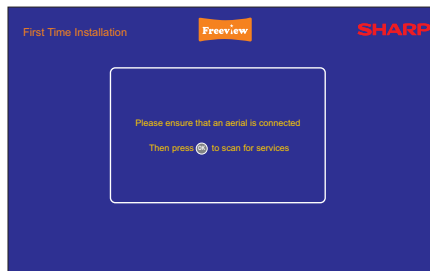

Watching TV

Daily operation

Switching on/off

Standby mode

Select standby mode

If the Recorder is switched on, you can switch it to standby by pressing  on the remote control unit.

Switching on from standby

From standby, press  on the remote control unit.



NOTE

- If you are not going to use this Recorder for long periods of time, be sure to remove the power adapter from the supply. (Page 9).
- A small amount of electric power is still consumed with the Recorder in standby mode.

Adjusting the volume

Press the **VOL+** button to increase the volume and the **VOL-** button to decrease the volume.

Changing channels

With PROG +/-:



With 0-9:



Switching between channels

Switch between the current channel and the previous channel by pressing **LAST**. Each press of the **LAST** button will toggle between the current channel and the previous channel.

Programme information

- 1 Press the **INFO** button once to display times, channel, programme, start and finish dates.
- 2 Press the **INFO** button again to display additional information about the current programme.



Selecting a video output source

Once the Recorder is connected to your TV using either a HDMI cable or SCART cable, you can select the appropriate output source by pressing **AV** on the remote control unit.

Selecting an audio language

Some programmes are broadcast with multiple audio channels. Press **AUDIO** to display the audio menu.

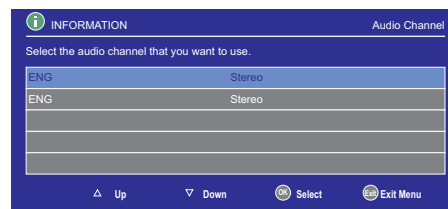

- 1 Press **▲/▼** to select the desired channel.
- 2 Press **OK** to confirm the audio channel.

Watching TV

Channel List

Basic operation

● Display/close the Channel guide

- 1 Press **Menu**.
- 2 Press **▲/▼** to select channels setting.
- 3 Press **OK**.

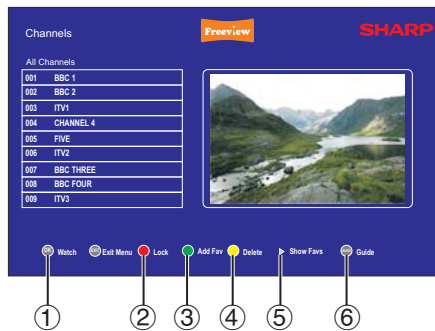

● Navigating the Channel guide

① Select a channel

Press **▲/▼** to select a channel. Press **OK** to watch the current programme.

Useful functions

② Lock a channel

You can lock a channel to prevent children viewing scenes of a violent or sexual nature.

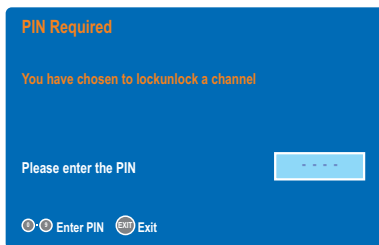

- 1 Press **▲/▼** to select the channel you want to lock.
- 2 Press the **RED** coloured button. A screen is displayed requesting a PIN entry. Enter a 4-digit code, then press **OK**.

NOTE

- If parental controls are enabled (Page 22), the parental settings PIN must be entered before a channel can be locked/unlocked.
- To unlock a channel, select the channel using the **▲/▼** buttons and press the **RED** coloured button. Enter the PIN, then press **EXIT**.

③ Set a channel as a favourite

You can set a channel as a favourite for quick access. All favourite channels will be displayed in the favourites list.

- 1 Press **▲/▼** to select the channel you want to add to the favourites list.
- 2 Press the **GREEN** coloured button.
 - The favourites list will be shown listing all favourite channels and the channel you have just added.
- 3 Press **◀** to return to the channel list.

NOTE

- To delete a channel from the favourites list, press the **YELLOW** coloured button. You can choose to delete the channel or cancel.

④ Deleting a channel

- 1 Press **▲/▼** to select the channel you want to delete.
- 2 Press the **YELLOW** coloured button.
 - The delete channel screen will be displayed. You can choose to delete the channel or cancel.

NOTE

- To view a channel once it has been deleted, you will need to perform a first time installation (Page 9).

⑤ Viewing the Favourites List

- 1 Press **▶** to view the favourites list
 - While viewing the favourite list, you can select and watch channels in the same way as the Channel List.
- 2 Press **◀** to return to the channel list.

⑥ View the EPG

- 1 To view the **EPG** (Page 12), press the **GUIDE** button.

Watching TV

Selecting a programme using the EPG

Basic operation

1 Display/close the EPG screen

Press **GUIDE**.

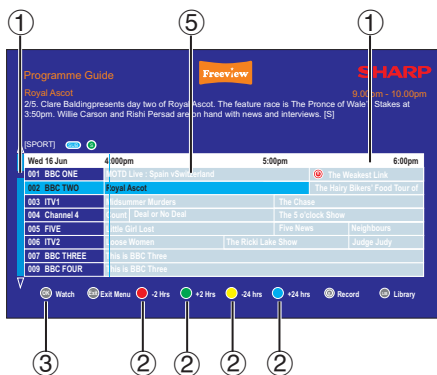

2 Select a programme

1 Select the desired programme

Press **▲/▼** to select the desired programme.

- If **▲** or **▼** are displayed on the left of the services, continue to Press **▲/▼** to display the next or previous screen.

Useful functions

2 Navigate the time span

- Press the **RED** coloured button to move backwards 2 hours.
- Press the **GREEN** coloured button to move forwards 2 hours.
- Press the **YELLOW** coloured button to move backwards 24 hours.
- Press the **BLUE** coloured button to move forwards 24 hours.

Watch a programme

3 Watch a programme now

- Press **▲/▼** to select a programme.
- Press **OK** to watch the programme.

Set a reminder

Set a reminder for a programme

- Press **▲/▼/◀/▶** to select a future programme.
- Press **OK**. A clock icon will be shown next to the selected programme.

NOTE

- If you set a reminder, just before the programme start time, a message will appear reminding you that the programme is about to start. You can choose to automatically switch channels or cancel the reminder.

EPG recommendations



When you press the **REC** button on the EPG to record an event, the receiver will check if there is a recommendation for that event. If there is a recommendation for the event, the receiver will ask you if you want to accept the recommendation. If you accept the recommendation, it will be scheduled for recording as well as the original event in the EPG on which **REC** was pressed. If you do not accept the recommendation (by pressing **BACK** or **EXIT**), only the original event in the EPG on which **REC** was pressed will be scheduled. Pressing **EXIT** will exit the menu without booking the item.

Watching TV

Trailer bookings

When the receiver detects a trailer booking suggestion is being broadcast, it will raise the following menu:

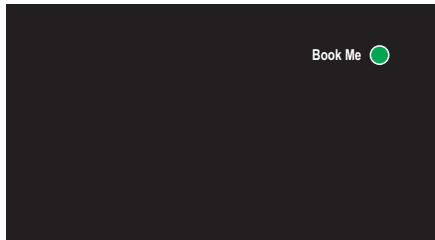

This menu consists of an icon on the screen, indicating that you can press the GREEN coloured button to invoke the trailer booking menu. The icon menu will disappear automatically if you do not press the GREEN coloured button and the broadcast is no longer signalling the trailer booking suggestion.

If you do press the GREEN coloured button, the receiver will show the following menu:



This menu allows you to select the item to book. Pressing **OK** will book the item, placing it in the scheduled recordings list. Pressing **EXIT** will exit the menu without booking the item.

Digital text

What is digital text?

Some channels are broadcast with digital text which contains pages of information and entertainment. News, weather, sports information, stock exchange prices and programme previews are among the many services.

Accessing digital text

- 1 Select a channel which broadcasts digital text.
- 2 Press **TEXT** or the RED button.
 - Not all channels broadcast digital text.
 - You may not be able to receive digital text if you have a poor quality signal.

Buttons for digital text operation

Buttons	Description
▲ / ▼ / ◀ / ▶	Navigate the digital text index page and menu system
Coloured buttons	Access digital text shortcuts. These are often displayed on the bottom of the page.
Numeric buttons 0-9	Directly select a page.
EXIT / TEXT	Exit digital text.

Recording TV

Recording a programme

Record a programme now

Press the **REC** button on the remote control. A message will appear briefly to confirm the current recording operation for the selected programme.

NOTE

- The programme being recorded will appear in the Library (see Page 26).

Record a future programme

- Press **GUIDE**.
- Press **▲ / ▼ / ◀ / ▶** to select a programme.
- Press the **REC** button on the remote control. A black record icon will appear next to the selected programme title.
- The scheduled recording will appear in the library where it can be edited/deleted (see Page 26).

Record multiple/alternative programmes

It is possible to record or schedule two individual programmes at the same time. If you select more than two recordings, you will see an error message:

WARNING Recording Clash

Your Freeview+ DTR is already recording two different channels.

What would you like to do?

- Record 'South Africa Walks' Ehen on Thur 00:20
- Switch Recording of 'Coronation Street' to Thur 00:10
- Switch Recording of 'Channel 4 News' to at 20:00

OK Select Exit Exit Menu

- Press **▲ / ▼ / ◀ / ▶** on the remote control to highlight one of the three options.
- Press **OK**. The screen returns to normal viewing.

Playing a recorded programme

Play a recorded programme

- From the Library (see Page 26), press **▲ / ▼ / ◀ / ▶** on the remote control to select a programme you want to watch.
- If the programme has not yet been watched, it will start playback from the start of the recording.
- If part of the programme has already been watched, the following screen appears:

INFORMATION Resume Playback

You have already watched part of this programme.

Press Blue to watch from the start, or OK to resume playback.

Restart OK Resume Exit Exit Menu

- Make your selection using the buttons on the remote control.

Stop a recorded programme

To stop playback of a recorded programme, press the **STOP** button on the remote control (see Page 4).



Library

Library details

The Library shows a list of the programmes previously recorded and/or currently being recorded (see Page 26).

Library

Freeview SHARP

Wed 16 Jun 2010 BBC ONE
2:38pm - 2:39pm MOTD Live: Spain v Switzerland
Gary Lineker introduces live coverage from Durban. Spain are favourites to win a first-ever World Cup. Switzerland are appearing in their ninth match. Also in HD. (S)

Programme	Channel	Time	Status
Breakfast	BBC ONE	1506	Recorded
Deal or No Deal	Channel 4	1506	Viewed
The Simpsons	Channel 4	1506	Recorded
EastEnders	BBC ONE	1506	Failed
Escape to the Country	BBC ONE	1606	Recorded
Royal Ascot	BBC ONE	1606	Recorded
MOTD Live: Spain v Switzerland	BBC ONE	1606	Recorded

69% Remaining

Stop Guide Protect Schedule Preview Delete Select Exit Menu

Connecting external devices

● Before connecting ...

- Be sure to turn off the Recorder and any external equipment before making connections.
- Firmly connect a cable to a terminal or socket.
- Carefully read the operation manual of each external device for possible connection types. This also helps you get the best audiovisual quality to maximise the potential of the Recorder and the connected device.

NOTE

- The cables illustrated in Pages 15 to 17 are commercially available items.

Video connections

HDMI connection

Example of connectable devices

- HD Ready TV

The HDMI connection permits digital video and audio transmission via a connection cable to a TV. The digital picture and sound data are transmitted without data compression and therefore lose none of their quality. Analogue to digital conversion is no longer necessary in any connected devices, which would also result in quality losses.

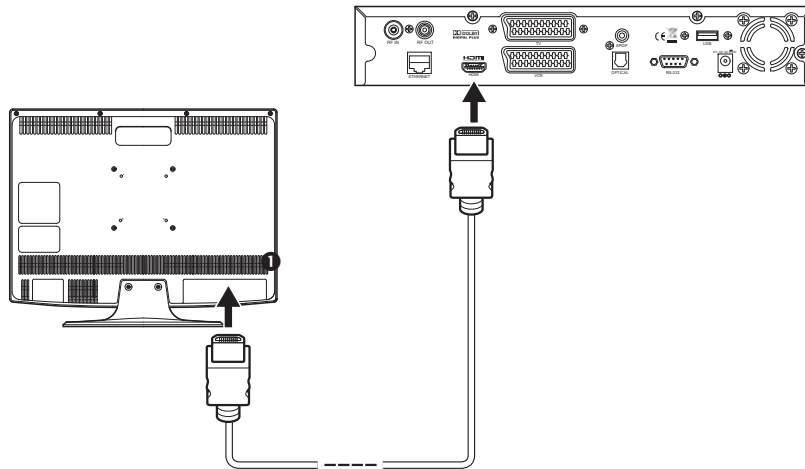

- ① HDMI-certified cable

Connecting external devices

SCART connection

Example of connectable devices

- HD Ready TV
- DVD Recorder

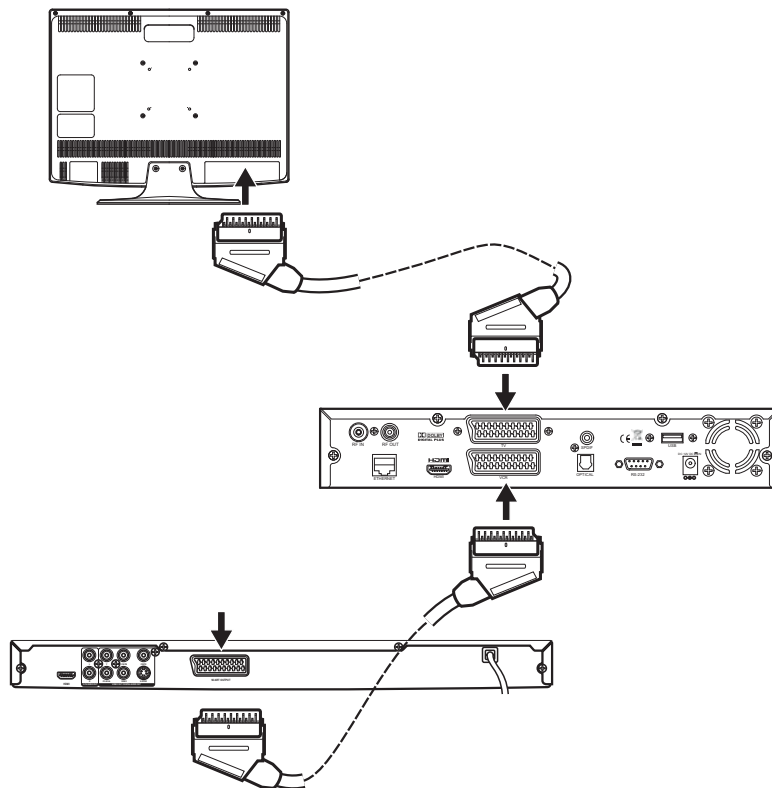

Connecting external devices

Audio connections

SPDIF connection

Example of connectable devices

- Dolby Digital Surround Sound System

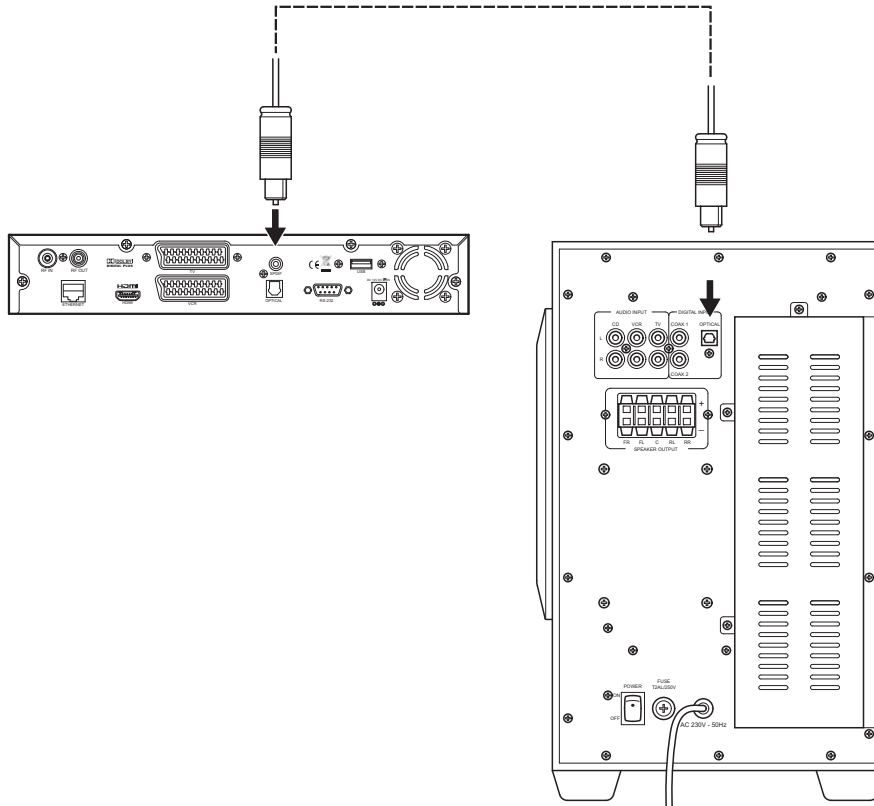

● After connecting

Digital audio output setting

After connecting to a surround sound system with a SPDIF cable, you should set an audio output format compatible with the programme you are watching or the device connected.

Menu operation

What is the MAIN MENU?

- You need to call up the on screen display (OSD) to perform settings for the Recorder. The OSD for the settings is called "MAIN MENU"
- The "MAIN MENU" enables various settings and adjustments.

Basic operation

1 Display the MAIN MENU screen

Press **MENU** and the "MAIN MENU" screen displays.

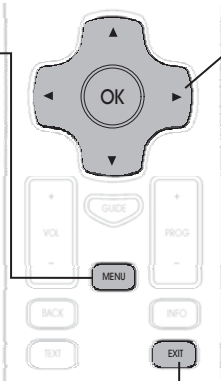
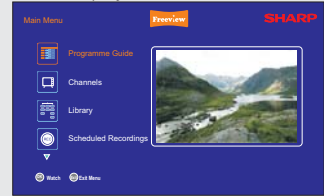

2 Selecting a menu or sub menu

Press **▲/▼** to select one of the main menu options. Press **▶** to display the option. Press **▲/▼** to select one of the sub menus. Press **◀/▶** to display the sub menu. Press **◀/▶** to adjust the desired setting and then press **OK**. Press **BACK** to return to the previous menu.

Selecting a sub-menu in the MAIN MENU

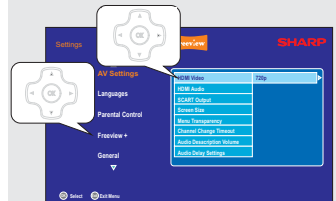

Selecting and adjusting options

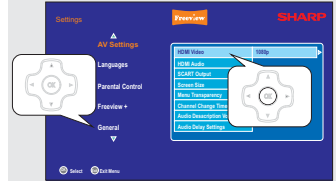

3 Exit the MAIN MENU screen

Press **EXIT** to exit the MAIN MENU at any time. If you have not pressed **OK** before exiting, the desired setting will not be changed.

About the guide display

- The guide display at the bottom of the MAIN MENU screen shows operations with the OSD.
- The guide display is an operational guide for the remote control unit. The bar will change in accordance with each sub-menu and menu setting.



Main Menu Options

The MAIN MENU allows you access to various menu screens.

	Item
Programme Guide	View the EPG (Page 12).
Channels	View the Channel List (Page 11).
Library	View the Library (Page 26).
Scheduled Recordings	View the Scheduled Recordings (Page 26).
Settings	Adjust various settings for the Recorder (Page 19).
Information	View system and software information for the Recorder.

Basic adjustment

AV Settings

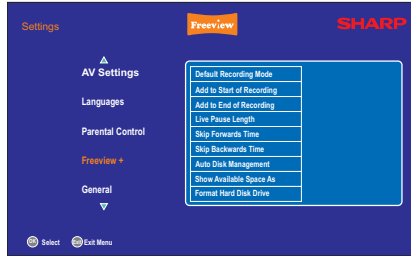

AV Settings HDMI Video

Adjusts the video resolution when the Recorder is connected to your TV using a HDMI cable. This allows you to watch High Definition (HD) TV.

Item	
576p	Sets the video resolution to 576p.
720p	Sets the video resolution to 720p.
1080i	Sets the video resolution to 1080i.
1080p	Sets the video resolution to 1080p.

NOTE

- Consult the documentation supplied with your TV to select the correct TV resolution.
- If your TV is not HD Ready but has a HDMI socket, select the 576p video resolution.

AV Settings HDMI Audio

Adjusts the audio output type when the Recorder is connected to surround sound system using a HDMI cable. This allows you to enjoy realistic live sound.

Item	
Stereo	The Recorder will output Stereo sound when connected to a standard surround sound system using the HDMI cable.
Dolby Digital	The Recorder will output Dolby Digital surround sound when connected to a compatible surround sound system using the HDMI cable.

NOTE

- Only select Dolby Digital if you have a compatible surround sound system. If you choose this setting with a non-compatible sound system the audio will not be heard.
- Not all channels are broadcast with Dolby Digital sound.

AV Settings SCART Output

Adjusts the video signal type when the Recorder is connected to your TV using a SCART cable.

Item	
RGB	This selects an RGB video signal type. The video signal will be splits the video output into separate red, green and blue signals to provide the best picture quality.
Composite	This selects a composite video signal. Produces a single composite video signal which provides poor picture quality.

NOTE

- If your TV is not compatible with RGB signals, select the Composite video output.

AV Settings Screen Size

Adjusts the screen size (aspect ratio) between 16:9 widescreen and various 4:3 picture sizes.

Item	
16:9 Widescreen	Displays a 16:9 widescreen picture. This ensures the best aspect ratio for widescreen TVs.
4:3 Widescreen (16:9)	In this mode, the picture is stretched towards each side of the screen. This displays a picture similar to 16:9 widescreen on 4:3 TVs.
4:3 Centre Cut Out	Displays a 4:3 picture in the centre of the screen. With some programmes, bars may appear on the left and right hand side of the screen.
4:3 Letterbox (16:9)	Displays a 16:9 picture in the centre of the screen. With some programmes, bars may appear on the top and bottom of the screen.

NOTE

- If you have connected the Recorder to a Widescreen TV, you should select the 16:9 Widescreen setting.
- The wide mode feature lets you adjust the screen size using the WIDE button on the remote control unit. Press WIDE to cycle through the available screen sizes while watching TV.
- If you have selected 16:9 widescreen in the AV settings menu, the wide mode will have no effect.

Basic adjustment



AV Settings

Menu Transparency

This function allows you to adjust the transparency of the OSDs.

Item	
Off	The picture will not be visible behind the OSD.
25%	The picture will be partially visible behind the OSD.
50%	The picture will be mostly visible behind the OSD.
75%	The picture is clearly visible behind the OSD.

NOTE

- The menu transparency settings will not affect the "MAIN MENU".



AV Settings

Channel Change Timeout

This function allows you to adjust the length of time that information screen is displayed for if no other buttons are pressed

Audio Description

Some programmes are broadcast with audio descriptions (AD) which provides a voice-over describing visual information such as scenery, body language and facial expressions.

Press **AD** on the remote control unit to toggle audio description on or off.

NOTE

- If audio description is available for a programme, the AD symbol will be displayed in the Information Screen (Page 10) and the EPG (Page 12).
- When turning the AD function ON or OFF you may notice a brief loss in audio. This is not a fault.



AV Settings

Audio Description Volume

Adjusts the volume of the audio description when available.



AV Settings

Audio Delay Settings

Synchronises the audio and video outputs when the Recorder is connected to a Dolby Digital Surround Sound System using the SPDIF (digital audio output) connection.



- 1 Press **▲/▼** to increase or decrease the audio delay time.
- 2 Press **EXIT** to complete the setting.

Basic adjustment

Languages

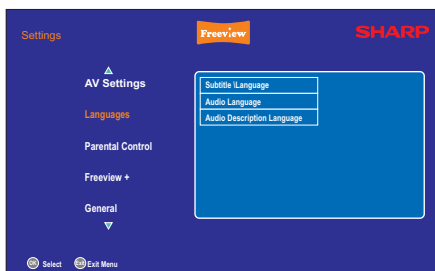

Languages

Subtitle Language

This function allows you to set the default subtitle language to English, Welsh, Gaelic or Irish.

NOTE

- Some subtitle languages are available with enhanced subtitles. These provide additional information about the programme for the hard of hearing.

Switching on subtitles

Press **SUBT** on the remote control unit to toggle subtitles on or off.

NOTE

- Not all programmes are broadcast with subtitles. If subtitles are available for a programme, the SUBT symbol will be displayed in the Information Screen (Page 10) and the EPG (Page 12).
- If subtitles are available they will be displayed at the bottom of the screen in the default subtitle language.

Languages

Audio Language

This function allows you to set the default audio language to English, Welsh, Gaelic or Irish.

Selecting audio languages

Press **AUDIO** on the remote control unit to toggle switch between the available audio languages.

NOTE

- Not all programmes are broadcast with alternative audio languages. If the selected audio language is not broadcast, English will be used.

Languages

Audio Description Language

This function allows you to set the default audio description (AD) language to English, Welsh, Gaelic or Irish.

NOTE

- Not all programmes are broadcast with alternative audio description languages. If the selected audio description language is not broadcast, English will be used.

Basic adjustment

Parental Control

The Parental Control feature allows you to prevent accidental changes being made to the Recorder. In addition channels can be locked to prevent children viewing scenes of a violent or sexual nature.

Parental Settings PIN

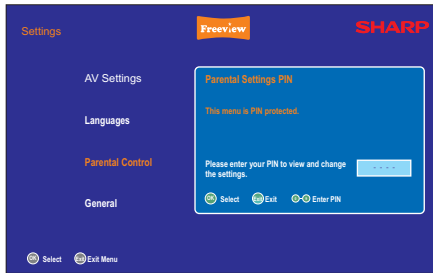

The default personal identification number (PIN) must be entered before the parental control settings can be adjusted.

Enter the default four digit PIN (0000) using the **0-9** numeric buttons, then press **OK**.

NOTE

- If you have changed the default PIN, this must be entered before the parental control settings can be adjusted.

Parental Control Guidance PIN for recordings

This function is broadcaster dependant and restricts playback of Guidance flagged content.

Item	
Yes	This will allow playback to be performed with a PIN entry.
No	This will allow playback to be performed without a PIN entry.

Parental Control Allow first time installation

This function allows you to prevent a first time installation being performed without first entering the parental settings PIN.

Item	
Enabled	This will allow a first time installation to be performed without entering the parental settings PIN.
Disabled	This will prevent a first time installation to be performed unless the parental settings PIN is entered.

Parental Control Allow parental changes

This function allows you to prevent changes within the parental control menu without first entering the parental settings PIN.

Item	
Enabled	This will allow access to the parental control menu without first entering the parental settings PIN.
Disabled	This will prevent access to the parental control menu unless the parental settings PIN is entered.

Parental Control Allow Hard Disc Drive format

This function gives the option to allow the hard disc drive to be formatted or not.

Item	
Enabled	This will allow the Hard Disc Drive to be formatted.
Disabled	This will prevent the Hard Disc Drive from being formatted.

Parental Control Change PIN

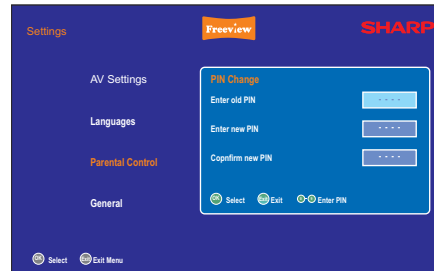

This function allows you to change the PIN.

● Changing the parental settings PIN.

- Enter the default (0000) or current four digit PIN using the **0-9** numeric buttons.
- Enter the new four digit PIN using the **0-9** numeric buttons.
- Confirm the new four digit PIN using the **0-9** numeric buttons.

NOTE

- As a precautionary measure, make a note of your PIN on the back of this operational manual, cut it out and keep it in a safe place that children cannot reach.

Basic adjustment

Freeview+

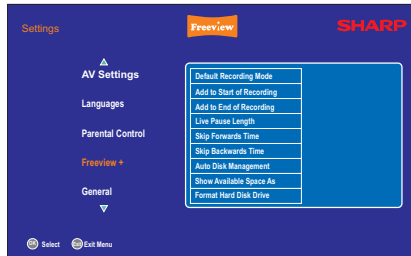

Freeview+ Default Recording Mode

This function allows you to select the mode for recording programmes when recording from a SD channel and the same programme is available in HD.

	Item
Always Ask	Whenever recording is selected, a message will appear on screen. You can select to record either in High Definition or Standard Definition quality.
High Definition	Recording is performed in High Definition.
Standard Definition	Recording is performed in Standard Definition.

Freeview+ Live Pause Length

This allows you to set a time limit that a Live TV programme can be paused. This can be either 60 or 120 minutes duration.

Freeview+ Skip Forwards Time

This function allows you to set a time interval for skipping forwards through a recorded programme. This can be selected from either 10, 30, 40 or 60 seconds.

Freeview+ Skip Backwards Time

This function allows you to set a time interval for skipping backwards through a recorded programme. This can be selected from either 10, 30, 40 or 60 seconds.

Freeview+ Auto Disk Management

When Auto Disk Management is turned on, if the recorder runs out of space whilst recording, old recordings will automatically be deleted to create free space. The internal hard drive can store up to 120 hours of digital TC broadcast (depending on the data rate of the recorded programme, which is set automatically set by the broadcaster).

NOTE

- Occasionally, the Recorder may miss the start or the end of the recording. This is not a fault of the unit, as the broadcaster may have not updated the information.

Freeview+ Show Available Space As

This function allows you to select how much space left on the Hard Disk Drive is displayed on screen.

	Item
Percentage of Total Space	This displays the space remaining as a percentage.
Hours (High Definition)	This displays the space left for recording in High Definition.
Hours (Standard Definition)	This displays the space left for recording in Standard Definition.

Freeview+ Format Hard Disk Drive

This function allows you to format the hard disk drive.

NOTE

- Formatting the hard disk drive will erase all recorded programmes.

Basic adjustment

General

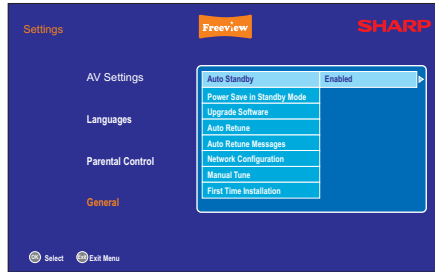

General Auto Standby

This function allows you to automatically switch the Recorder into standby mode when there is no user activity for 3 hours.

Item	
Enabled	The Recorder will automatically switch into standby mode when there is no user activity for 3 hours.
Disabled	The Recorder will remain on constantly unless switched into standby mode by the user.

General Power Save in Standby Mode

This function allows you to control the power saving features of your Recorder.

Item	
Enabled	The Recorder uses a very low amount of power when in standby.
Disabled	Power saving features are disabled.

General Upgrade Software

This function allows you to control when software upgrades are installed.

Item	
Automatic	The Recorder will automatically install software upgrades when available.
Manual	The Recorder will display a message allowing you to confirm or cancel the software upgrade.

General Auto Retune

This function allows you to control when new services (channels) are added and stored on the Recorder.

Item	
Always Start	Whenever new services (channels) are detected, the Recorder will automatically tune and store them.
Always Ask	Whenever new services (channels) are detected, a message will appear on screen. You can choose to tune and store the new services or cancel the auto retune.

General Auto Retune Messages

This function controls when retune messages are displayed.

Item	
All	All messages are displayed.
No Minor Messages	Only major messages are displayed.
Information Only	Only information messages are displayed.
None	No messages are displayed.

NOTE

- During the digital switchover, Auto retune messages may be displayed. Follow the on-screen instructions to retune.

General Network Configuration

This function allows you to configure the network.

Basic adjustment

Manually tuning channels



General

Manual tune

You can manually tune new services after the first time installation has been completed.



You can manually tune new services after the first time installation has been completed.

- 1 Press ◀▶ to select the desired UHF channel.
- 2 Press ▼ to select 'Frequency (kHz)'.
3 Press ◀▶ to adjust the frequency.
- 4 Press ▼ to select 'Bandwidth'.
5 Press ◀▶ to adjust the 'bandwidth'.
- 6 Press ▼ to select 'System'.
7 Press ◀▶ to select a 'System'.
- 8 Press the BLUE coloured button to start scanning for the specified channel. If the channel is found it will be stored in the Recorder and will be available in the channel list and EPG.

Item	
UHF Channel	The channel number you want to save the manually tuned channel as.
Frequency	The frequency of the service (channel) you are manually tuning.
Bandwidth	The bandwidth of the service (channel) you are manually tuning.
System	The type of tuning system

NOTE

- You can enter the UHF Channel and Frequency using the 0-9 numeric buttons.



General

First time installation

This function allows you to perform a first time installation (page 9).

Basic adjustment

Library

1 Display/close the LIBRARY screen

Press the **LIBRARY** button on the remote control or select **Library** from the **Main Menu**.



1 Stop

This stops playback of a previewed recording, selected with the **STOP** button on the remote control.

2 Guide

Press the **GUIDE** button on the remote control to view the programme guide.

3 Protect

This function allows you to protect a selected recording, selected with the **RED** button on the remote control. A **P** will appear on the right hand side in the selected programme row.

4 Schedule

This function takes you to the Scheduled Recordings menu.

5 Preview

This function allows you to preview a selected recording, selected with the **YELLOW** button on the remote control.

6 Delete

This function allows you to delete a selected recording, selected with the **BLUE** button.

7 Select

Press the **OK** button on the remote control to make a selection.

8 Exit Menu

Press the **EXIT** button on the remote control to exit the current screen.

9 Hours Remaining

This displays the available space on the Hard Disk Drive for recording.

Scheduled Recordings

1 Display/close the Scheduled Recordings screen

Select **Scheduled Recordings** from the **Main Menu**.

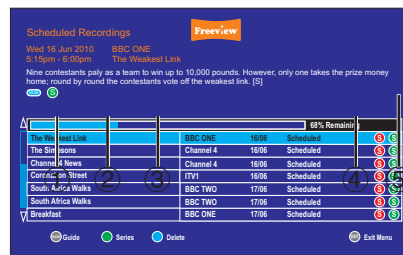

1 Guide

Press the **GUIDE** button on the remote control to view the programme guide.

2 Series

This function lets you select a repeated scheduled recording for recording as a series of programmes. This is selected with the **GREEN** button on the remote control.

3 Delete

This function allows you to delete the selected scheduled recording. This is selected with the **BLUE** button on the remote control.

4 Exit Menu

Press the **EXIT** button on the remote control to exit the current screen.

5 Information Row

This row gives the details of the scheduled recording, including the programme title, the channel number, the date of the programme and its current status.

Appendix



Troubleshooting

The following conditions in the table below do not always indicate a problem. Please perform the checks described below before calling for service. If the problem can not be corrected by the use of this manual, remove the mains plug from the power socket and contact the Helpline on 0845 880 0421 in order to obtain service or advice. Where this is not possible please visit our web site www.sharp.co.uk/customersupport.aspx

Customers without Internet access may phone 0845 880 0421 during office hours. In the unlikely event of this equipment requiring repair during the guarantee period, you will need to provide proof of purchase to the repair company. Please keep your purchase invoice or receipt in a safe place.

WARNING

Under no circumstances should you try and repair this product yourself. This will invalidate the warranty. Do not open the unit as there is risk of electric shock.

Problem	Possible solution
<ul style="list-style-type: none">No power.	<ul style="list-style-type: none">Check if you pressed  on the remote control unit.Is the AC power adapter disconnected?Check if you pressed  on the Recorder.
<ul style="list-style-type: none">The Recorder cannot be operated.	<ul style="list-style-type: none">External influences such as lightning, static electricity, etc., may cause improper operation. In this case, operate the Recorder after first turning off the power, or unplugging the AC power adapter and re-plugging it in after one or two minutes.
<ul style="list-style-type: none">Remote control unit does not operate.	<ul style="list-style-type: none">Are batteries inserted with polarity (+, -) aligned?Are batteries worn out? (Replace with new batteries.)Are you using it under strong or fluorescent lighting?Is a fluorescent light illuminating the remote control sensor?
<ul style="list-style-type: none">Picture is cut off.	<ul style="list-style-type: none">Are screen mode adjustments (WIDE MODE) such as picture size made correctly? (Page 19)
<ul style="list-style-type: none">Power is suddenly turned off.	<ul style="list-style-type: none">The Recorder's internal temperature has increased. Remove any objects blocking the vent or clean.Is auto standby activated? (Page 24)
<ul style="list-style-type: none">No picture.	<ul style="list-style-type: none">Are connections to external equipment correct? (Pages 15 to 17)Is the input signal type selected correctly after connection? (Page 19)Is the correct output source selected? (Page 10)Is the antenna connected properly? (Page 9)Hold the HDMI button on the remote control for 5 seconds to reset the output to 1080i. (Page 19)
<ul style="list-style-type: none">No sound.	<ul style="list-style-type: none">Is the volume too low?Check if you pressed mute on the remote control unit.
<ul style="list-style-type: none">The Recorder sometimes makes a cracking sound.	<ul style="list-style-type: none">This is not a malfunction. This happens when the casing slightly expands and contracts according to changes in temperature. This does not affect the Recorder's performance.
<ul style="list-style-type: none">Freezing / Blocking	<ul style="list-style-type: none">Check Freeview reception information as we have listed on the front of the manual.Refer to page 9 to perform the First Time Installation.
<ul style="list-style-type: none">There is noise interference on the TV while a broadcast is being received.	<ul style="list-style-type: none">Depending on the reception of the broadcast, interference may appear on the picture while you watch a TV broadcast and the unit is left on. This is not a malfunction of the unit.
<ul style="list-style-type: none">Unit is making a humming / whirring noise	<ul style="list-style-type: none">The unit has a fan and hard drive installed. This noise is not a malfunction of the unit.

Cautions regarding use in high and low temperature environments

- When the Recorder is used in a low temperature space (e.g., room, office), the picture may leave trails or appear slightly delayed. This is not a malfunction, and the Recorder will recover when the temperature returns to normal.
- Do not leave the Recorder in a hot or cold location. Also, do not leave the Recorder in a location exposed to direct sunlight or near a heater.

Unrecordable Material

In the unlikely event that there is some problem like loss of recorded video or audio content due to HDD malfunction, please be aware beforehand that Sharp will bear no responsibility to compensate for the content that could not be recorded or edited, for the loss of recorded or edited video, or for other related direct or indirect damages.

If a power failure occurs

- The content being recorded or timer recorded may be damaged if power failure occurs.
- The content being played back may be damaged.

For important recording

- If the HDD malfunctions, the content recorded on the HDD may be lost. If you wish to save the content permanently, we recommend copying or moving the content to Video or DVD.

Appendix

Specifications

Item		TU-T2HR32 Digital Terrestrial HD Recorder for Freeview HD		
Tuner / Demodulator	Receiving Signal Type (DVB-T)	All combinations of the below parameters can be received and automatically detected. (Except bandwidth).		
		Channel Bandwidth	7, 8 MHz	
		Modulation Type	QPSK, 16QAM, 64QAM	
		FFT Mode	2K, 8K	
		Code Rate	1/2, 2/3, 3/4, 5/6, 7/8	
		Guard Interval	1/4, 1/8, 1/16, 1/32	
	Receiving Signal Type (DVB-T2)	All combinations of the below parameters can be received and automatically detected. (Except bandwidth).		
		Channel Bandwidth	7, 8 MHz	
		Modulation Type	QPSK, 16QAM, 64QAM, 256QAM	
		FFT Mode	1K, 2K, 4K, 8K, 16K, 32K	
		Code Rate	1/2, 3/5, 2/3, 3/4, 4/5, 5/6	
		Guard Interval	1/4, 5/32, 1/8, 5/64, 1/16, 1/32, 1/64, 1/128	
System	CPU / Clock	STi7105/ST40 core, 450MHz		
	Transport	DVB Demultiplexer		
	Hard Disk Drive	320Gb		
	Flash Memory	16MB		
	System Memory	128MByte X 2 DDR		
	Software	Pixsan Elgist and MHEG middleware		
Video	CPU Core	ST231 / 450MHz		
	Video Standards	MPEG-1 ISO/IEC 11172-2 MPEG-2 MP@ML and MP@HL, ISO/IEC 13818-2 MPEG-4 AVC MP@L4 and HP@L4.1		
	Field / Frame Rate	60/30 Hz for NTSC or 50/25 Hz for PAL		
	HD/SD Decoding Capability	Interlaced Mode/ Progressive Mode: 1080i, 720p, 576p, and 576i		
	Aspect Ratio	16:9 Widescreen 4:3 Widescreen (16:9) 4:3 Centre Cut Out 4:3 Letter Box (16:9)		
	Video Input / Output	Digital Video HDMI with HDCP supported CVBS, R/G/B for TV SCART OUT CVBS for VCR SCART OUT CVBS, R/G/B for VCR SCART IN		
	Output Modes	HD	1080P / 1080i / 720p / 576p Output format changed by specific hot-key (software switchable)	
		SD	576i	
Teletext / Subtitle	Decoding and display for supporting Closed Captions & Teletext			
Audio	CPU Core	ST231/ 450MHz		
	Audio Standards	MPEG-1 layer I & layer II, MP3 MPEG-2 layer II, Dolby Digital MPEG-2 AAC/AAC+		
	Audio Input / Output	AL/AR for TV SCART OUT (Volume adjustable) AL/AR for VCR SCART OUT (Fixed volume) AL/AR for VCR SCART IN Optical Digital Audio SPDIF		
	Digital Audio SPDIF Output Format	IEC-60958 for PCM data IEC-61937 for Encoded Bitstream Data		
	Sampling Rate	32, 44.1, 48, and 96 KHz		

Appendix

Item		TU-T2HR32 Digital Terrestrial HD Recorder for Freeview HD
Software Upgrade	Over Air Download	Yes, via DVB-SSU
	USB Port	Yes
Front Panel	Display	
	Keypad	Power
	IR Sensor	Yes
Rear Panel	RF Input Connector	F type, Female (for NTSC)/IEC type, Female (for PAL), 75 Ohm
	Loop Through Output Connector	F type/IEC type, Male/Female, 75 Ohm
	Stereo (left & right) Audio output CVBS, R/G/B video output	Dual SCART for TV/VCR For TV SCART: w/ OSD and Volume adjustable For VCR SCART: w/o OSD and fixed Volume
	Digital Video & Audio Output	HDMI Connector
	Optical Digital Audio SPDIF	TosLink Interface
	RJ 45	Ethernet connection with unique Mac address
	RS 232	Service only
Power Interface	Input Voltage	200~240 VAC, 50/60 z
Power Consumption	Normal Operation	17W@220V/60Hz
	Low Power Standby	0.8W
Others	Accessory	Customer Selectable Remote Controller (and Batteries) User's Manual RF Cable (1.1M)
	EMC/ Safety	Compliant to CE
	ATC	HDMI 1.4, HDCP
	Dolby	Dolby Digital Stereo, Dolby Digital+ (HE AAC)
	Software	Dbook 6.1 compliant Tested to DTG Test Suite Audio Description, Recorder mix MHEG5 HD Dbook 6.1 MHEG5 interaction channel MHEG5 iPlayer ready

PIN CODE reminder

--	--	--	--

NOTE

- You need to insert the PIN code here and refer it to the pages in the manual where this is covered.

NOTE

- Removal of a PIN code could be subject to a service charge and if you would like to use this feature the PIN code should be written down.

Trademarks

- "HDMI, the HDMI logo and High-Definition Multimedia Interface are trademarks or registered trademarks of HDMI Licensing LLC."

- Manufactured under license from Dolby Laboratories.
- "Dolby" and the double-D symbol are trademarks of Dolby Laboratories.

Appendix

End of life disposal



Attention: Your product is marked with this symbol. It means that used electrical and electronic products should not be mixed with general household waste. There is a separate collection system for these products.

A. Information on Disposal for Users (private households)

1. In the European Union

Attention: If you want to dispose of this equipment, please do not use the ordinary dust bin!

Used electrical and electronic equipment must be treated separately and in accordance with legislation that requires proper treatment, recovery and recycling of used electrical and electronic equipment. Following the implementation by member states, private households within the EU states may return their used electrical and electronic equipment to designated collection facilities free of charge*. In some countries* your local retailer may also take back your old product free of charge if you purchase a similar new one. *) Please contact your local authority for further details.

If your used electrical or electronic equipment has batteries or accumulators, please dispose of these separately beforehand according to local requirements.

By disposing of this product correctly you will help ensure that the waste undergoes the necessary treatment, recovery and recycling and thus prevent potential negative effects on the environment and human health which could otherwise arise due to inappropriate waste handling.

2. In other Countries outside the EU

If you wish to discard this product, please contact your local authorities and ask for the correct method of disposal.

For Switzerland: Used electrical or electronic equipment can be returned free of charge to the dealer, even if you don't purchase a new product. Further collection facilities are listed on the homepage of www.swico.ch or www.sens.ch.

B. Information on Disposal for Business Users

1. In the European Union

If the product is used for business purposes and you want to discard it:

Please contact your SHARP dealer who will inform you about the take-back of the product. You might be charged for the costs arising from take-back and recycling. Small products (and small amounts) might be taken back by your local collection facilities.

For Spain: Please contact the established collection system or your local authority for take-back of your used products.

2. In other Countries outside the EU

If you wish to discard of this product, please contact your local authorities and ask for the correct method of disposal.



The battery supplied with this product contains traces of Lead.

For EU: The crossed-out wheeled bin implies that used batteries should not be put to the general household waste! There is a separate collection system for used batteries, to allow proper treatment and recycling in accordance with legislation. Please contact your local authority for details on the collection and recycling schemes.

For Switzerland: The used battery is to be returned to the selling point.

For other non-EU countries: Please contact your local authority for correct method of disposal of the used battery.

Important Notice

Digital Switchover and Your TV Equipment

WHAT YOU NEED TO DO TO ENJOY WATCHING TV DURING AND FOLLOWING DIGITAL SWITCHOVER

Starting in 2008 and ending in 2012, television services in the UK will go completely digital, TV region by TV region.

To continue using this digital TV equipment during and following digital switchover, you will need to "reset" your digital TV channels.

Users of this product must reset their channels on at least 2 different occasions, normally 1 month apart when switchover happens. Digital UK, the body leading digital TV switchover, and broadcasters will advise you when to reset your channels on each occasion.

If you do not reset your channels, you risk losing some or all of your TV services during and following switchover.

Please refer to Page 24 of this manual for help with resetting channels.

Please note that in order to receive the maximum number of available TV services on your equipment you must perform a first time installation and do not just add channels.

If you have questions relating to digital switchover please don't hesitate to call us on 0845 6 50 50 50 or visit www.digitaluk.co.uk.

The FREEVIEW service is subject to coverage. An aerial upgrade may be required. The FREEVIEW PLAYBACK word and logo are trade marks of DTV Services Ltd and are used under licence.
© DTV Services Ltd 2006.

SHARP

TERMS OF GUARANTEE

Sharp Electronics (UK) Ltd. ("Sharp") guarantees to provide for the repair, or at its option the replacement, of this product subject to the conditions listed below:

1. This guarantee shall only apply to faults which are due to inferior workmanship or materials. It does not cover faults or damage caused by accident, misuse, fair wear and tear, signal related issues, neglect, tampering with the product, or repair other than by a Service Facility appointed by Sharp.
2. As this product is intended for private domestic use only, the guarantee will not apply if the product is used in the course of a business, trade or profession.
3. To benefit from this guarantee, any fault which occurs must be notified to Sharp, or its appointed Service Facility within one year from the date this product was purchased. Proof of purchase must be provided.
4. In the unlikely event of this product requiring repair, please contact the Sharp DTR help line on 0845 880 0421.
5. No person has any authority to vary the terms or conditions of this guarantee.
6. This guarantee is offered as an additional benefit to your statutory rights, and does not affect these rights in any way.

If you have any difficulty operating this product, or would like information on other Sharp products, please telephone the Sharp DTR Help Line on the number given below.

Sharp DTR Help Line - 0845 880 0421

SHARP ELECTRONICS (U.K.) LTD.
4 Furzeground Way, Stockley Park, Uxbridge,
Middlesex, UB11 1EZ



Notes





SHARP[®]
SHARP CORPORATION

